

DELSTAR

HD BRUSHLESS | SERIES 170

100-17204,-D

28 Volts 240 Amps

PRODUCT SPECIFICATIONS

Part number	100-17204
System Voltage	24V
Rated Output	240A
Output @ 2000 rpm	90A
Ground	Isolated
Mounting	J180 4" Hinge
Rotation	Bidirectional
Temperature limits:	
Low	-40°C / -40°F
High	110°C / 230°F
High	125°C / 257°F (with fresh air intake)
Speed limits:	
	8000 RPM continuous
	9000 RPM intermittent
Coating	Corrosion-Resistant E-Coated
Weight	38 Lbs / 17.4 Kg.
Regulator	Integral
Excitation	Self-Excite
Indicator Light	Yes
Remote Sense	Yes
Soft Start Delay (SSD)	Yes
Load Response Control (LRC)	Yes
Overvoltage Shut-Down (OSD)	Yes
Field Short Circuit Protection	Yes
Load Dump Protection	Yes

RECOMMENDED FOR:

- School & Shuttle Buses
- Utility Vehicles
- Marine & Mining
- Agricultural
- Construction & Industrial



100-17204



100-17204-D
with air intake cover

NOTE:

This DelStar 100-17204 alternator, meets the marine requirements for Ignition Protection on gas or diesel engines of ISO 8846, USCG, stated in Title 33 CFR 183.410, SAE J1171 and International CE Standards.

PERFORMANCE CURVES

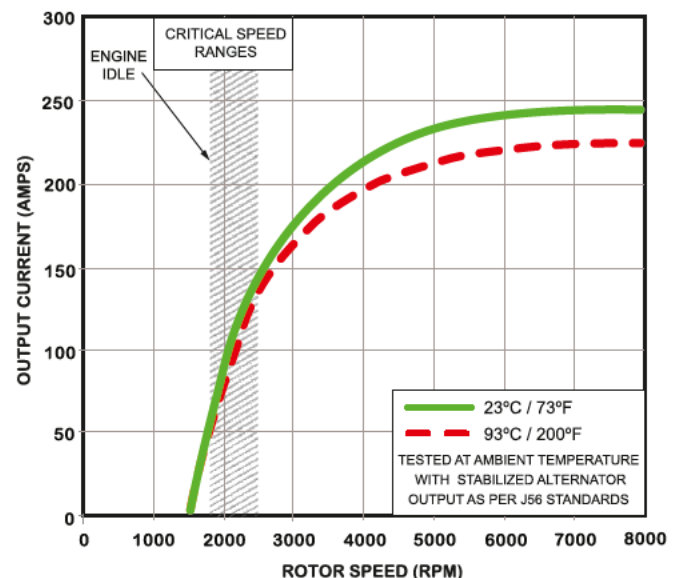

DELSTAR

HD BRUSHLESS | SERIES 170

OUTLINE

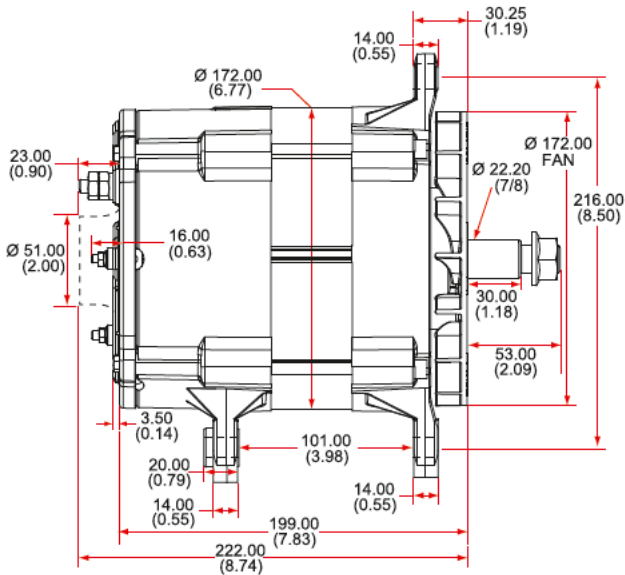

CONNECTIONS

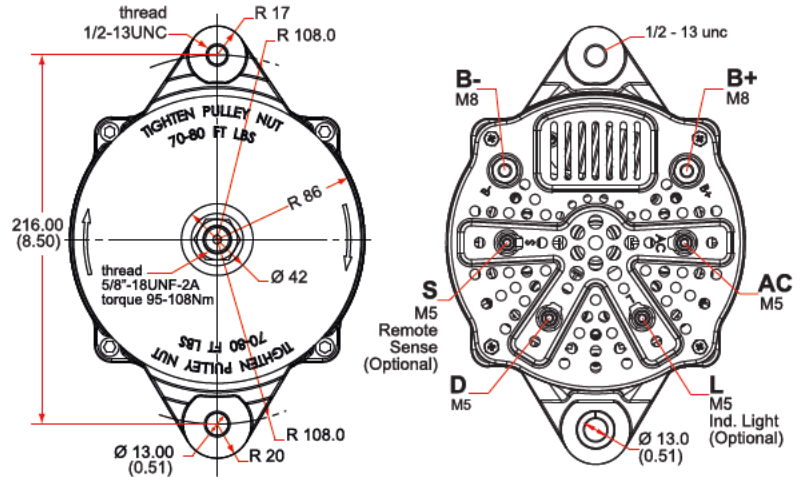

100-17204,-D

28 Volts 240 Amps

ELECTRICAL SCHEMATIC

